









### TEMPERATURE RANGE

<b>TN</b>		<b>-2°C / +7°C (PC-PV)</b>
<b>BT</b>		<b>-24°C / -18°C (PC)</b>
<b>BT</b>		<b>-20°C / -10°C (PV)</b>

### MAX CONDITION

<b>TN</b>		<b>38°C</b>		<b>60 UR%</b>
<b>BT</b>		<b>38°C</b>		<b>60 UR%</b>

COMPANY  
WITH QUALITY MANAGEMENT  
SYSTEM CERTIFIED BY DNV  
= ISO 9001:2000 =

## 700 L - TAMPONE

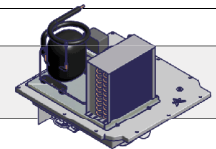

### Specifiche Tecniche - Specifications - Technische Daten - Données Techniques - Dato Técnicos

230 V / 50 Hz		RANGE	-2°C/+7°C	-24°C/-18°C	-2°C/+7°C PV	-20°C/-10°C PV
Codice prodotto Item code no	Produkt-Kode-Nr. Nr. de code du produit	inox*rosfr.St s/s*inox	8T070INC.....	8T070IBC.....	8T070INV.....	8T070IBV.....
Lunghezza esterna Outside length	Aussenlänge Longueur extérieure	mm	733	733	733	733
Altezza Height	Höhe Hauteur	mm	2090	2090	2090	2090
Profondità Depth	Tiefe Profondeur	mm	800	800	800	800
Capacità Capacity	Inhalt Capacité	dm <sup>3</sup>	600	600	600	600
Compressore Compressor	Kompressor Compresseur	ASPERA	NB 6165 GK	T2180GK	NB 6165 GK	T2180GK
Potenza frigorifera Refrigeration power	Kalorienleistung (Te:-10°C..-30°C/Tc :+45°C) Puissance frigorifique	kcal/h W	389 453	551 640	389 453	551 640
Fluido refrigerante Refrigerant fluid	Kältemittel Gas frigorigène	kg	R 404A 0.32	R404A 0.35	R 404A 0.32	R404A 0.35
Capillare / V.T. Capillary / V.T.	Kapillarrohr / V.T. Capillaire / V.T.	diam. mm V.T.	1.24 X 3300	TLK 1.0	1.24 X 3300	TLK 1.0
Ventilatore del cond. Condenser fan	Kondensatorlüfter Ventilateur du condensateur	W	10	16	10	16
Ventilatore dell' evap. Evaporator fan	Verdampferlüfter Ventilateur de l'évaporateur	W	10	10	10	10
Centralina elettronica Electronic central unit	Elektronisches Steuergehäuse Centrale électronique	CAREL	IR33	IR33	IR33	IR33
Potenza assorbita Absorbed power	Leistungsaufnahme Puissance absorbée	W / I max (A)	525 / 3.4	820 / 6.4	525 / 3.4	924 / 6.7
Consumo giornaliero/24h Daily consumption/24h	Tagesverbrauch/24h UNI EN 441-9 Consommation par jour/24h	kWh/24h	6,43	14.5	7.4	15.7
Resist. Sbrinamento Defrosting heater	Abtauheizung Resistance degivrage	W	400	400	400	400
Illuminazione Lighting	Beleuchtung Eclairage	W	15	15	36	36
Peso Weight	Gewicht Poids	Kg	142	148	145	154

**DIMENSIONI-DIMENSIONS**

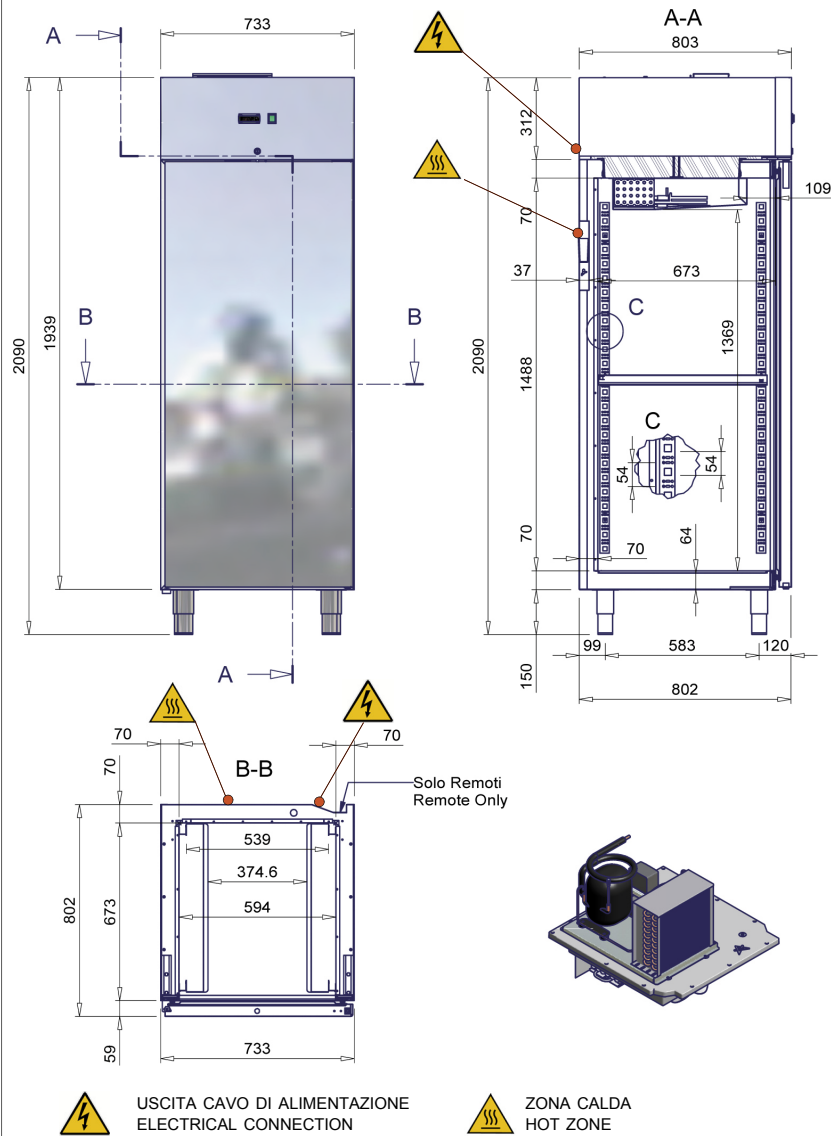

**ACCESSORIAMENTO-ACCESSORIES**

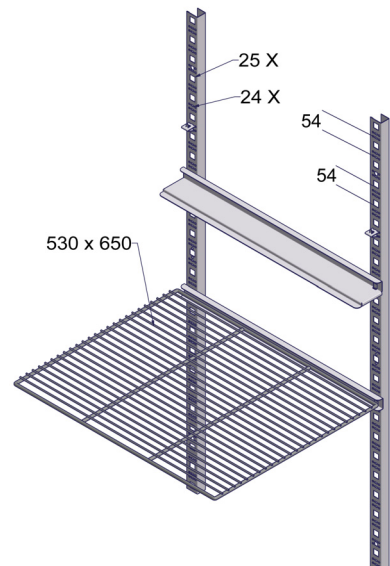

**MINIMA AREA INSTALLAZIONE  
MINIMUM INSTALLATION AREA**

